

SIRUBA®

銀箭牌工業用縫紉機

INDUSTRIAL SEWING MACHINE

L818F-DM1

零件圖 PARTS LIST







From the library of: Diamond Needle Corp

CE

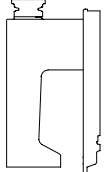
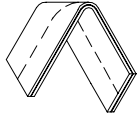
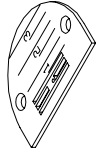
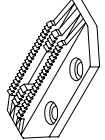
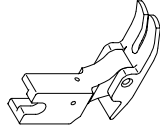
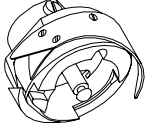

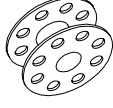
高林股份有限公司
KAULIN MFG. CO., LTD.

								
MODEL	SUB-CLASS	NEEDLE PLATE	FEED DOG	PRESSER FOOT	HOOK ASM	BOBBIN CASE ASM	BOBBIN	NEEDLE
機 型	規 格	針 板	送 具	押 具	梭 頭	梭 殼	梭 子	針 號
L818F-DM1	半無油式 中厚布料	E704	D701	P701	G111	G201	G301	DB*1#11
L818F-DM1A		E704D	D702	P701	G111	G201	G301	DB*1#11
L818F-DM3	無油式 中厚布料	E701	D701	P701	G141 G142	G206	G303	DB*1#11

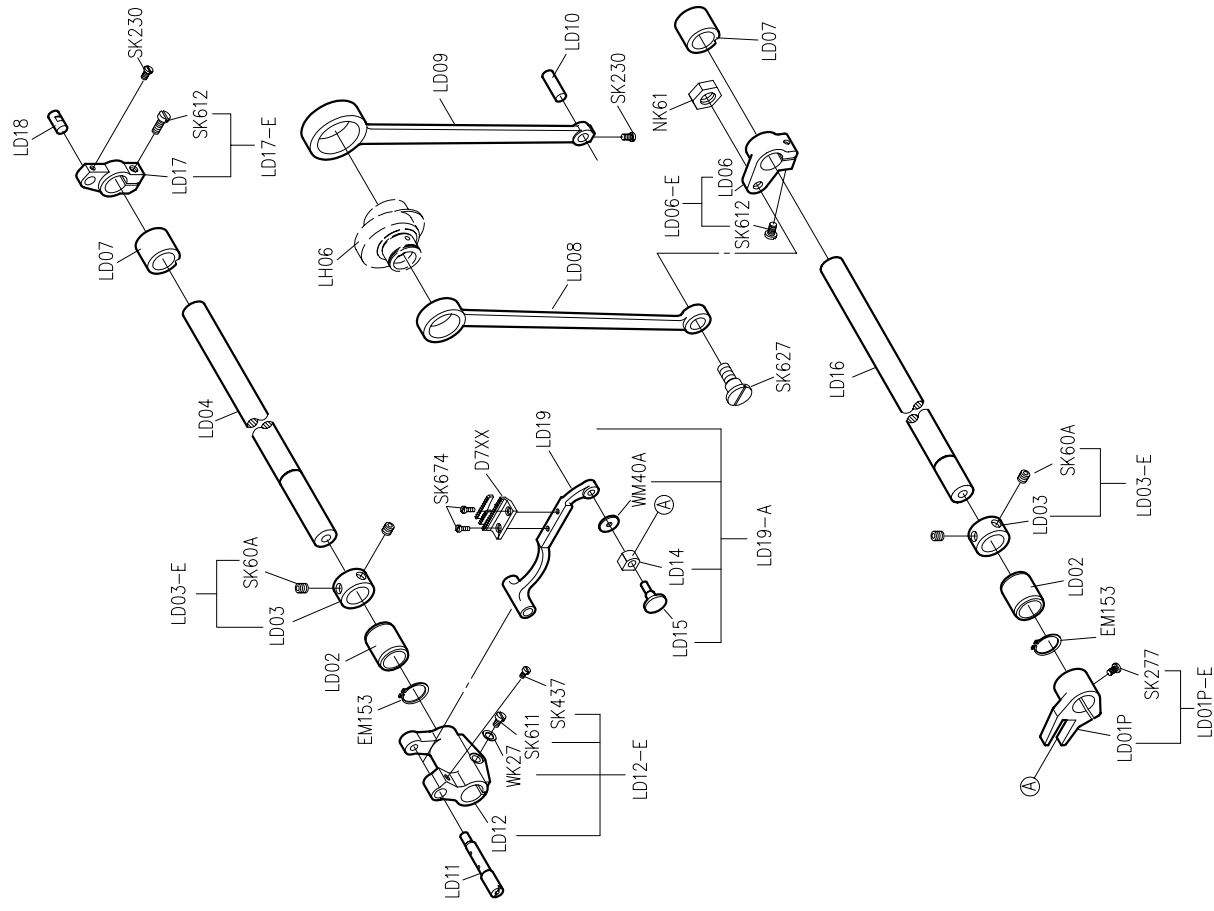
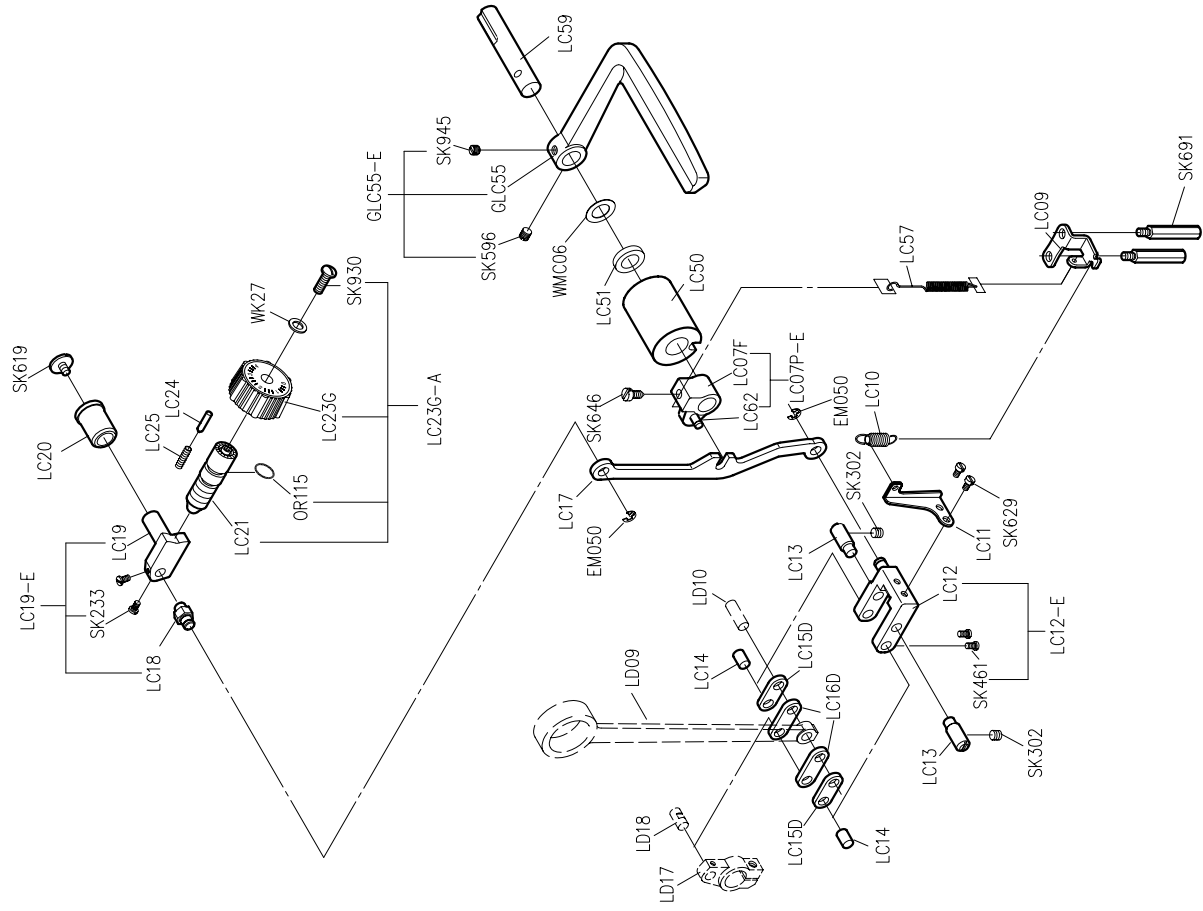

PARTS LIST FOR LE GROUP

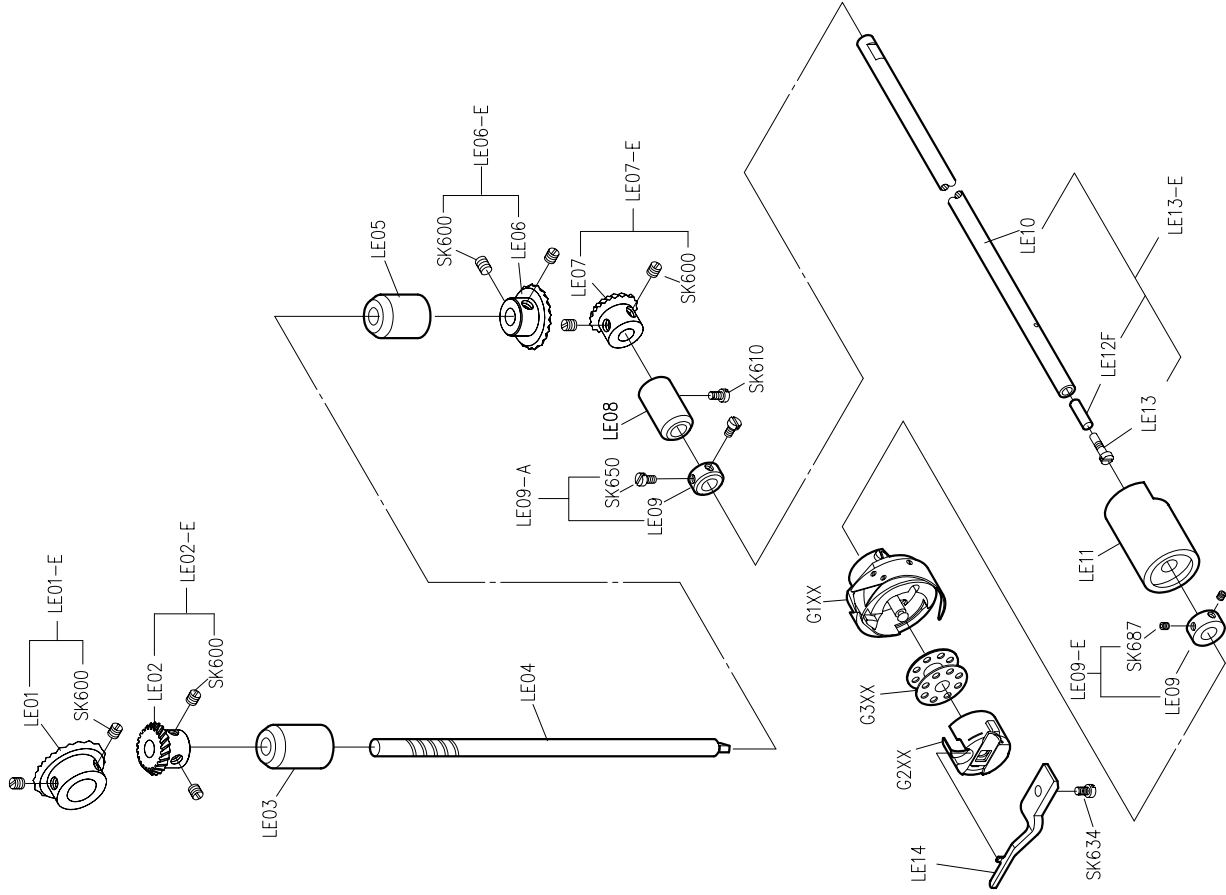

PARTS LIST FOR LG GROUP

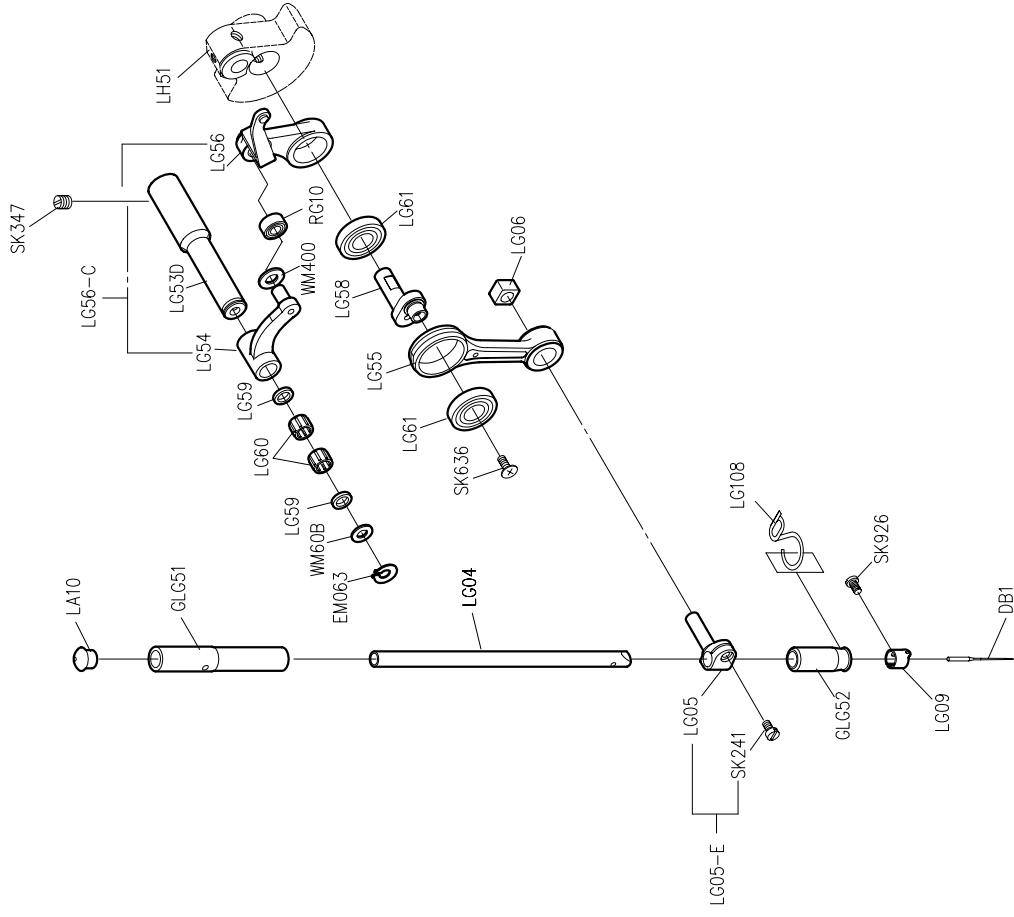

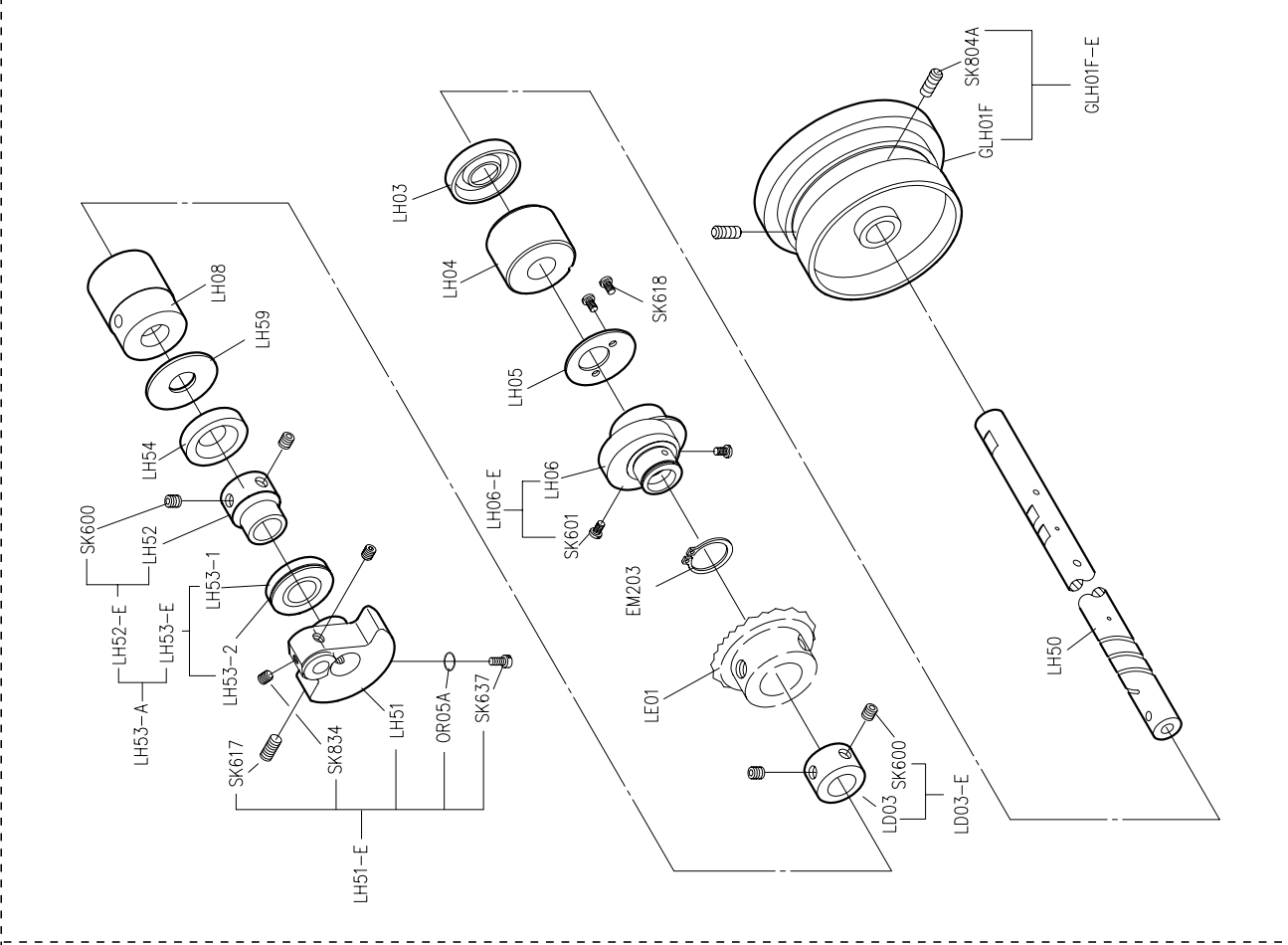
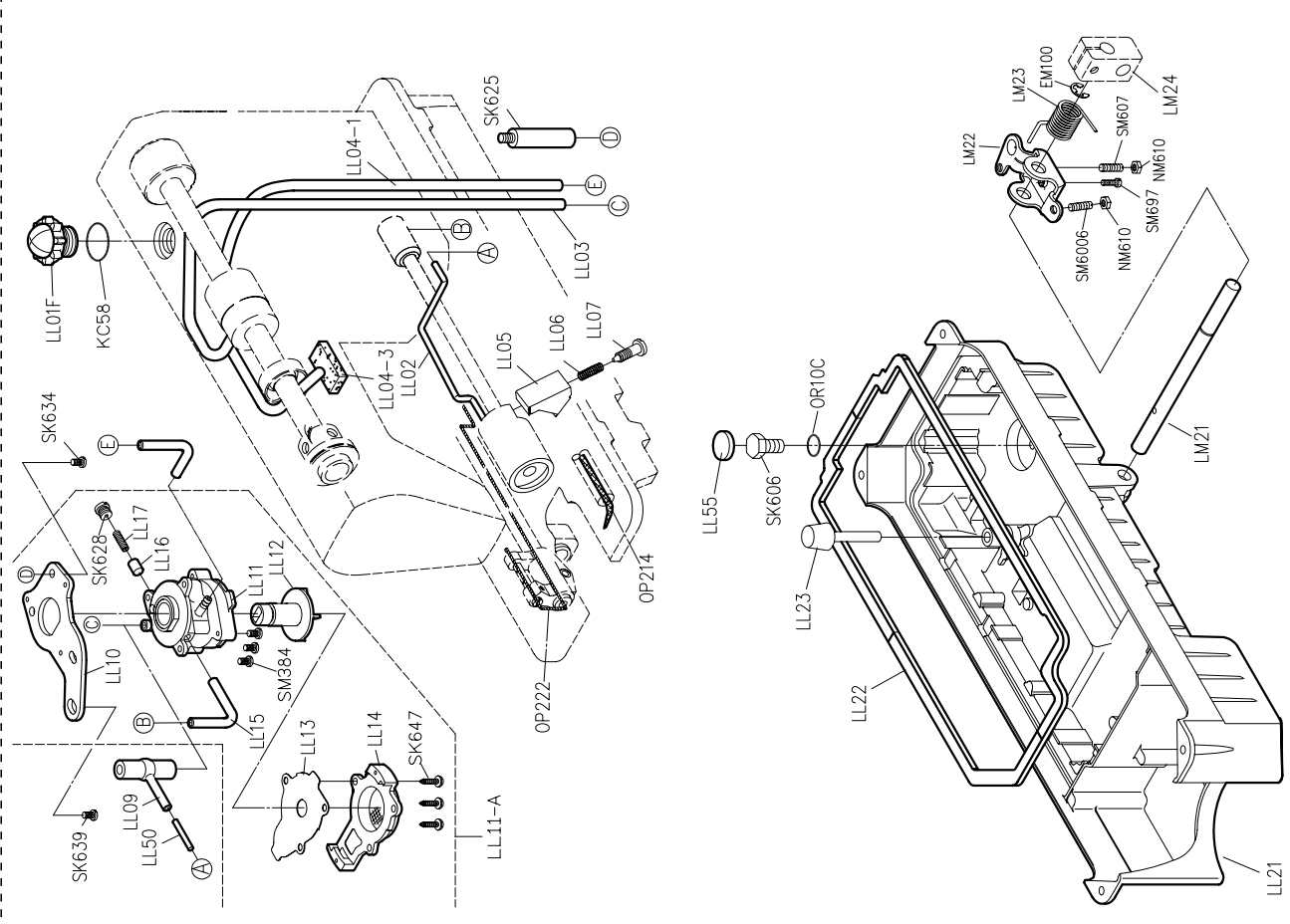

PARTS LIST FOR LM GROUP

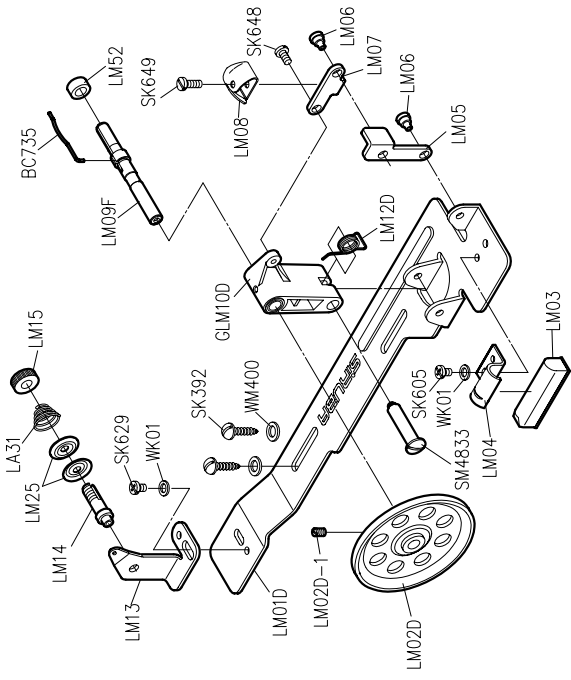

LM24-E

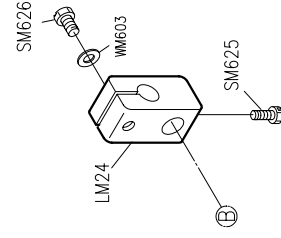

LM20-A

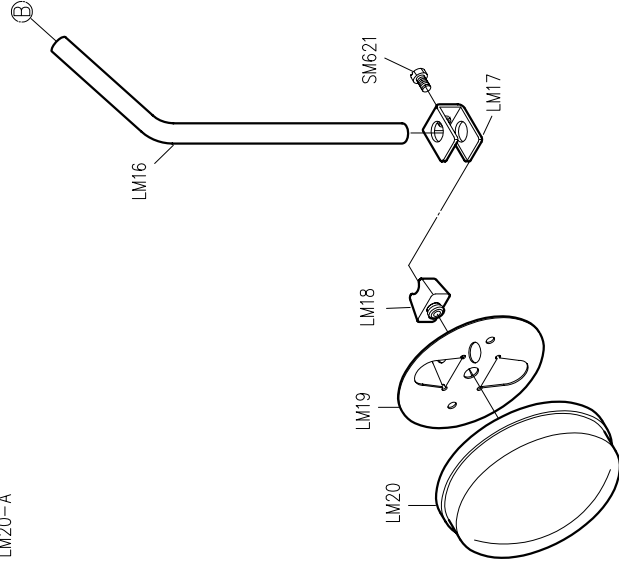

PARTS LIST FOR THREAD STAND GROUP

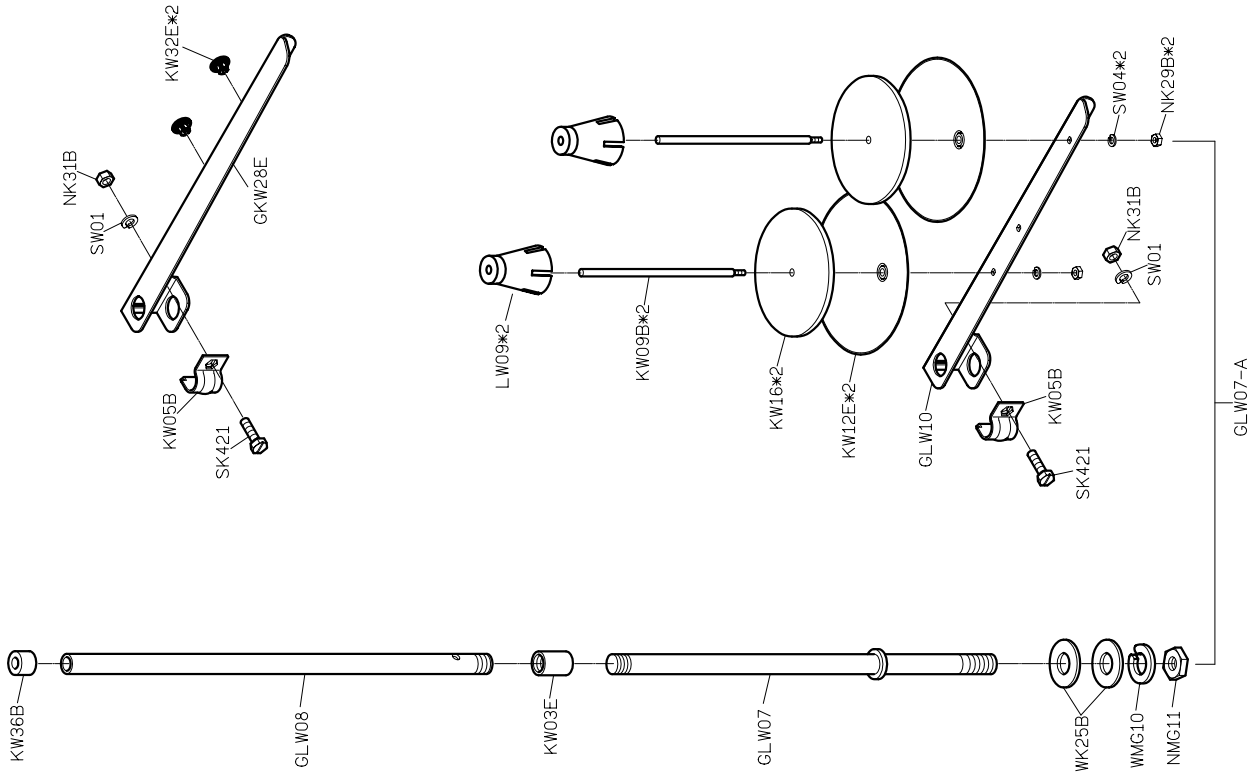

L Y01

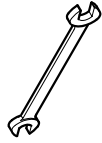

L Y02

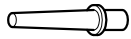

Y M04*2

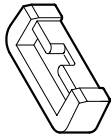

L Y05*2

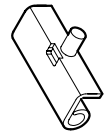

Y M102*2



L Y08F

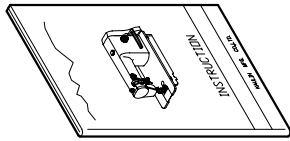

L Y18

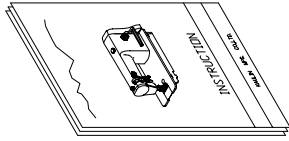

L Y26

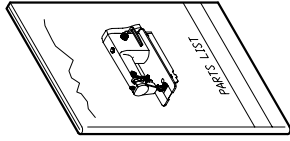

L Y21-A

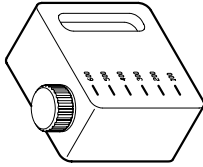

Y M103*2



G3XX*2



L Y20*8



針*2

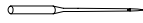

G M Y01

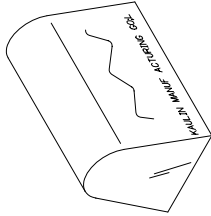

M Y11



3 mm

K Z03*1



M Y13



K Y16

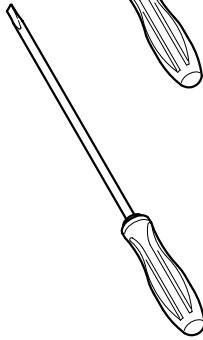

K Y17

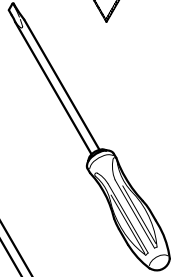

G K Y26F

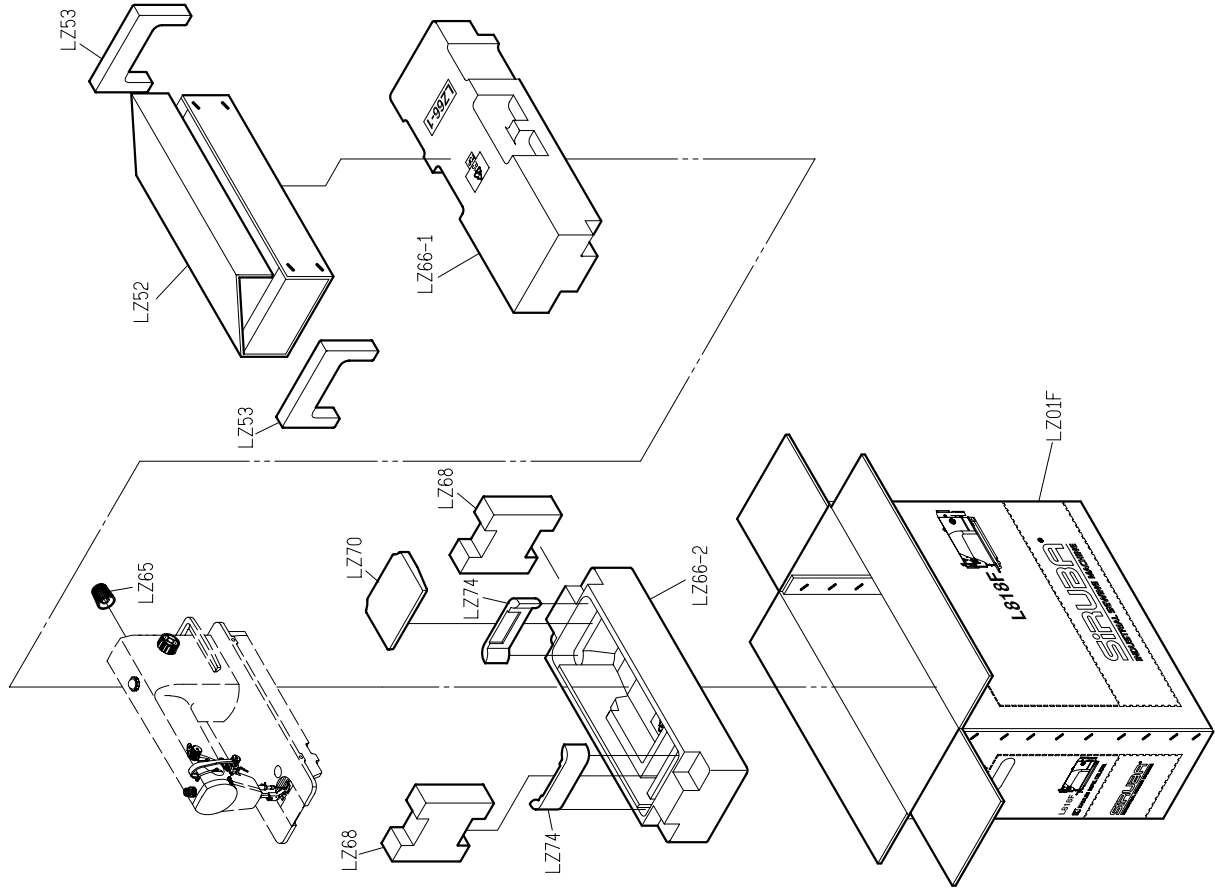



L818F-DM1

高林股份有限公司 KAULIN MFG. CO., LTD.

From the library of: Diamond Needle Corp